DMC 2000S

DMC 2000S
Electronic Dosimeter
User's Manual



Document # 15-00007
Revision 1
May 2001



REVISION LOG: DMC 2000S Electronic Dosimeter User's Manual

Revision #	Date	Revised Pages	Comments
0	10/21/98	N/A	Original MGPI document # 15-00007, based upon MGPSA document # 115170AA
1	05/01/01		Revised for new firmware version of DMC 2000
		Page 20	Moved 'SAT' to the end of section (5.3.2)
		Page 23	Moved 'Dosimeter Serial' number to the beginning of section (5.3.2)
		Page 35	Added 'Watch/Clock' function to section (6.4.2)
		Page 35	Added description and function of 'EXT' mode (exercise training) to section (6.4.2)
		Page 54	Added 'Calibration Mode' in section (10.1.4)
		All	Added 'Warning' to pre-alarms
		All	Changed all units in graphics and units to reflect 'mRem' and mRem/h
	Page 63	Updated part numbers	

TABLE OF CONTENTS

1.	General	6
1.1	Document overview	6
1.2	Contents	6
1.3	Direct access to information	8
1.4	Conventions	8
1.5	Illustrations	8
2.	Operating modes of the DMC 2000S dosimeter	9
2.1	Operating Mode	9
2.1.1.	Autonomous mode	9
2.1.2.	Satellite mode	9
2.2	Dosimeter function mode	9
2.2.1.	<i>Dosimeter storage mode</i>	9
2.2.2.	<i>Pause mode</i>	10
2.2.3.	<i>Measurement mode</i>	10
2.2.4.	Compatibility	10
3.	Description	11
3.1	Front view	11
3.2	Back view	11
3.3	Display	12
	The dosimeter's top-mounted display allows viewing of measurements and alarms.	12
4.	Start-up	13
4.1	Satellite mode	13
4.2	Autonomous mode	13
5.	Operation in the satellite mode	14
5.1	Switching to measurement mode	14
5.2	Operation in the measurement mode	14
5.2.1.	Displaying the dose equivalent measurement	14
5.2.2.	Dose equivalent saturation	15
5.2.3.	Displaying the dose rate measurement	15
5.2.4.	Dose rate saturation	15
5.2.5.	Fault and alarm indicators	16
5.2.6.	Viewing alarm thresholds	16
	Switching to pause mode	18
5.3	Operation in the pause mode	19
5.3.1.	Normal display	19
5.3.2.	Operation of the selector button	20
5.4	"Pass-by" reading	23
6.	Operation in the autonomous mode	24
6.1	Switching to the measurement mode	24
6.2	Operation in the measurement mode	25
6.2.1.	Displaying the dose equivalent measurement	25

6.2.2.	Dose equivalent saturation	25
6.2.3.	Displaying the dose rate measurement	26
6.2.4.	Dose rate saturation	26
6.2.5.	Fault and alarm indicators	27
6.2.6.	Viewing alarm thresholds	27
6.3	Switching to pause mode	29
6.4	Operation in the pause mode	30
6.4.1.	Normal display	30
6.4.2.	Operation of the selector button	31
7.	Alarms	37
7.1.1.	Dose pre-alarm	37
7.1.2.	Rate pre-alarm	38
7.1.3.	Dose alarm	39
7.1.4.	Dose rate alarm	39
7.1.5.	Time alarm	40
8.	Setting operating parameters	41
8.1	In the satellite mode	41
8.2	In the autonomous mode	41
8.3	Modifiable parameters	41
8.4	Modifying parameters	45
8.4.1.	Accessing the modification mode	45
8.4.2.	Procedures for modifying parameters	46
8.4.3.	Example for setting parameters	47
9.	Other functions	50
9.1	Emergency start-up	50
9.2	Historical	51
10.	Faults	52
10.1.1.	Battery low	52
10.1.2.	“Defective” battery	53
10.1.3.	Historical fault	53
10.1.4.	Calibration fault	54
10.1.5.	Detector fault	55
10.1.6.	E2PROM fault	56
10.1.7.	Initialization fault	56
10.1.8.	Integrated circuit fault	56
11.	Maintenance	57
11.1	Changing the battery	57
12.	Technical characteristics	59
12.1	Physical characteristics	59
12.1.1.	Isotropic graph	60
12.1.2.	Linearity graph	60
12.2	Functional characteristics	61
12.3	Electrical characteristics	61
12.4	Mechanical characteristics	62
12.5	Environmental characteristics	62

12.6	Link to LDM 2000 reader	62
12.7	Storage	62
13.	Replacement parts	63
14.	Appendix 1:	64
	connector for teledosimetry, alarm transmission or external probe	64
15.	Glossary	65

1. General

1.1 Document overview

This document provides the information for using the DMC-2000S electronic dosimeter in two operating modes:

- Part of a centralized dosimetry system
- Operation in the autonomous mode (i.e. as an individual or independent unit)

This document provides information about the dosimeter's functions (alarms, display), normal use (alarm acknowledgment) and first level maintenance (replacing the battery, troubleshooting). For additional information relating to the functions listed below, refer to the User's Manual for the centralized dosimeter system, such as MGPAC or DOSIVIEW.

- Assigning dosimeters
- Configuring dosimeters
- Pass-by readers

For some uses of the DMC 2000S (dosimetry system and teledosimetry applications) additional equipment is required (MGPAC, LDM, WRM...). For further information, refer to the corresponding equipment's User's Manual.

1.2 Contents

This document contains information regarding:

- *Operating modes* of the DMC 2000S

This section briefly describes the dosimeter's operating modes and function modes.

- *A description* of the DMC 2000S

This section describes the dosimeter from the user's point of view (selector button, display...).

- *Start-up* of the DMC 2000S

This section describes the start-up procedures for the dosimeter.

- Operation of the DMC 2000S in the *satellite mode*

This section details the normal conditions of use for the DMC 2000S as part of a dosimetry system.

- Operation of the DMC 2000S in *autonomous mode*

This section describes the use of a DMC 2000S in a “stand-alone” mode, independent of any peripheral reader.

- The *alarming functions* of the DMC 2000S

This section describes the different operating modes of the audible and visual alarms.

- *Setting the operating parameters* of the DMC 2000S

This section lists the main operating parameters of the DMC 2000S dosimeter, as well as the procedures to modify them.

- *Additional functions* of the DMC 2000S

This section describes the “emergency start-up” and “historical” functions.

- *Fault analysis* of the DMC 2000S

This section lists possible faults as well as providing a troubleshooting guide.

This section does not describe procedures to follow in the event of an alarm. Those procedures are detailed in the *alarm* section.

- Simple, first level *maintenance* of the DMC 2000S

This section describes how to troubleshoot the dosimeter.

- The *technical characteristics* of the DMC 2000S

This section describes the dosimeter’s physical, electrical and mechanical characteristics, and the environmental conditions of use.

- An appendix on *teledosimetry, alarm transmission, and external probe connector*

This appendix describes the input / output functions of the connector.

- A *glossary of terms*

1.3 Direct access to information

- This document provides basic information which may be needed to operate the DMC 2000S dosimeter. To assist the user in understanding the dosimeter’s operation, a glossary of terms has been provided at the end of the document that describes acronyms, abbreviations and terminology typically associated with the DMC 2000S.

1.4 Conventions

Use of typographical symbols:

Symbols “ ■ ” and “ □ ”:

These symbols are used for descriptions and lists.

The symbol “ ■ ” corresponds to the **first** level of a list.
 The symbol “ □ ” corresponds to the **second** level of a list.
 For legibility reasons, these symbols are aligned vertically.

1.5 Illustrations

On the illustrations of the display:

- shaded areas indicate that the information flashes
- the indicator light as shown below is flashing
- the “functional indicators” are always flashing unless otherwise specified

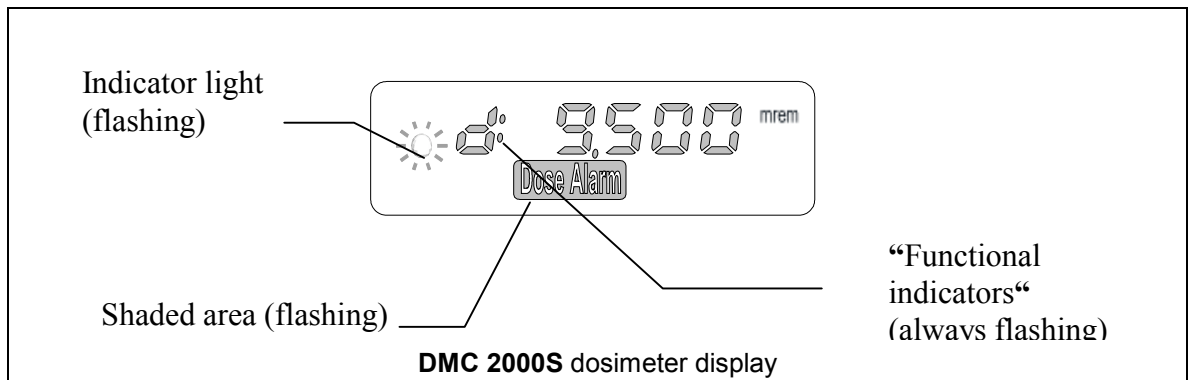

Note: the illustration above contains more data than the actual display for illustrative purposes.

2. Operating modes of the DMC 2000S dosimeter

The main operating modes and function modes of the **DMC 2000S** dosimeter are described below.

2.1 Operating Mode

The DMC 2000S can be used in two different operating modes: the “**autonomous**” mode and the “**satellite**” mode.

The mode selection is normally set at the factory. However, it can be selected by using the DOSIMASS software and an LDM 2000 reader.

Note: Please refer to the DOSIMASS User's Manual for instructions.

2.1.1. Autonomous mode

This mode allows the DMC 2000S to operate individually or independently, without any other equipment.

2.1.2. Satellite mode

This mode allows the DMC 2000S to be used as a part of a dosimetry system, which includes other equipment and software (LDM 2000, MGPAC, Sentinel etc.).

2.2 Dosimeter function mode

Regardless of its operating mode (“autonomous” or “satellite”), the DMC 2000S dosimeter is always in one of the following functional modes:

- *dosimeter storage*
- *pause*
- *measurement*

2.2.1. Dosimeter storage mode

When in this mode, the **DMC 2000S dosimeter** is not operational and its power consumption is at a minimum level.

Switching to this mode requires the use of a centralized dosimetry system.

2.2.2. *Pause mode*

When in this mode, the **DMC 2000S**:

- periodically monitors:
 - status of the battery
 - proper operation of the detector
 - integrity of calibration data and initialization parameters
 - management of the internally stored HISTOGRAM
 - permanently displays the message “**PAUSE**,” a **personalized message** or **messages indicating any faults** that have been detected

In this mode the “**pass-by data exchange**” function is operational.

*Note: the personalized message displayed in the **pause** mode can be set using the DOSIMASS software.*

2.2.3. *Measurement mode*

When in this mode, the **DMC 2000S** dosimeter continuously:

- performs measurements
 - of the Hp (10) dose equivalent
 - of the current dose rate
 - of the time spent in area
- displays the dose, alarms and messages relating to detected faults
- manages the alarms and pre-alarms
- manages the internally stored HISTOGRAM
- signals audibly, under alarm conditions
- periodically monitors:
 - the battery status
 - the detector’s operational status
 - the integrity of the initialization and calibration data

In this mode, the “**pass-by data exchange**” function is operational.

2.2.4. *Compatibility*

All functions of the DMC-90 and the DMC-100 dosimeters are available with the DMC 2000S, in particular, use with previous dosimeter readers (LDM-91, LDM-101, LDM-201) and dosimeter calibrators, CDM 21 and IRD 2000, equipped with new software. The user’s (display) area of message 22 has been reduced from 14 to 12 bits. Those sites using their own access control software may need to make modifications to the program in order to integrate the DMC 2000S into their system. Please contact MGPI for more information.

3. Description

3.1 Front view



3.2 Back view

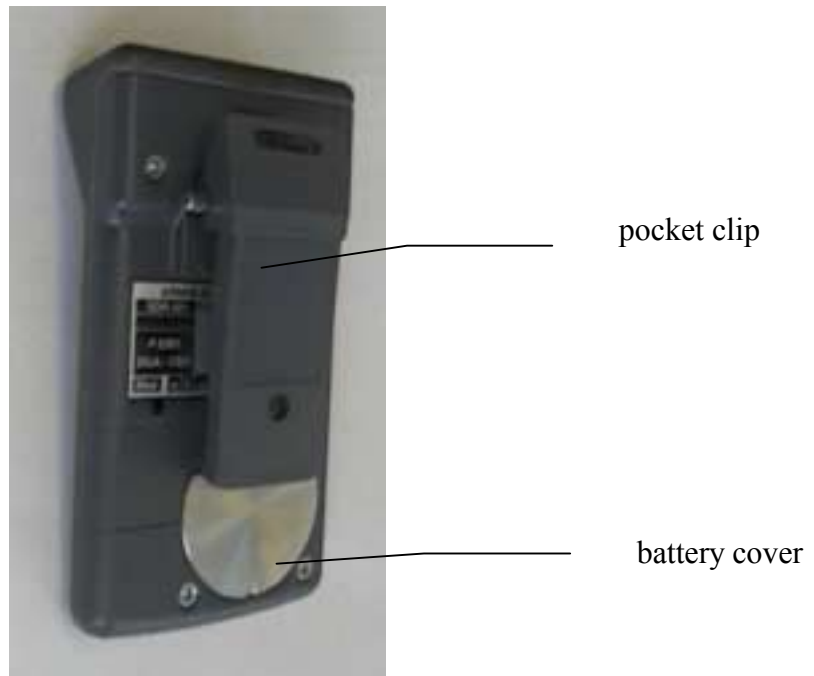

3.3 Display

The dosimeter's top-mounted display allows viewing of measurements and alarms.



In the example shown below the display indicates a dose alarm (i.e. the alarm threshold programmed into the dosimeter for the dose equivalent has been exceeded):

- the indicator light flashes
- the “ Dose Alarm ” indicator flashes
- the value of the dose is displayed (9.5 mRem)
- note that displayed units can be configured for mSv

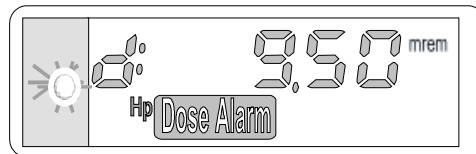

4. Start-up

To start up a **DMC 2000S** dosimeter, the following procedures must be performed:

- it must be initialized (i.e. switched from storage mode to pause mode)
- it must be configured (i.e. programmed for alarm threshold values, dose rate display authorization, alarm rate authorization, alarm duration, etc.)
- if in satellite mode, it must be assigned to an individual
- it must be activated (i.e. turned on for normal operation)

4.1 Satellite mode

In a centralized dosimetry system, a “server” computer performs the start-up procedure via an LDM 2000 reader.

4.2 Autonomous mode

For use in the autonomous mode, the initialization and initial configuration are generally performed at the factory.

Use of the selector button activates the dosimeter (refer to the section on *Setting operating parameters In the autonomous mode*, page 41).

In addition, modification of some parameters can also be performed when in the *pause* mode by using the selector button (refer to the section on *Setting operating parameters In the autonomous mode*, page 41).

5. Operation in the satellite mode

5.1 Switching to measurement mode

Switching to the *measurement* mode implies activating the **DMC 2000S** dosimeter to measure the wearer's dose equivalent.

In a centralized dosimetry system, switching to the *measurement* mode is accomplished when passing by an LDM 2000 access control reader.

When switching to the *measurement* mode, the display reads as shown below:

- the functional indicators flash
- the dose value is continuously displayed (in the appropriate units, as selected during dosimeter configuration)

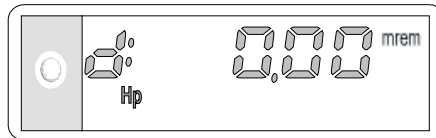

5.2 Operation in the measurement mode

5.2.1. Displaying the dose equivalent measurement

When in the measurement mode, the **DMC 2000S** dosimeter continuously measures the Hp(10) dose equivalent, as well as performing other operations (see section *Measurement mode*, page 10).

The display shows the dose value. The unit, format (fixed or floating point) and display resolution are selected during dosimeter configuration.

Example:

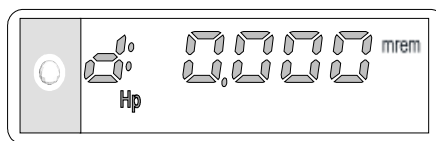

Note: when used in a centralized dosimetry system, the dose display can be intentionally blanked. In this case, only the “functional indicators” and faults are displayed.

5.2.2. Dose equivalent saturation

When the dose equivalent exceeds the value 999.9 Rem (9999.99 mSv), the display reads as shown below. This indicates that the dosimeter has become saturated and must be reset by the appropriate reader / software.

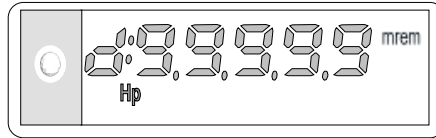

5.2.3. Displaying the dose rate measurement

Pressing and immediately releasing the selector button displays the dose rate value for 30 seconds. The unit, format (fixed or floating point) and display resolution are selected during dosimeter configuration.

After 30 seconds, the dose equivalent value is displayed once again:

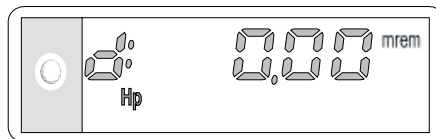

Note: other display combinations of dose/rate are available. Please contact MGPI for further details.

5.2.4. Dose rate saturation

When the dose rate exceeds the value 999.9 rem/h (9999 mSv/h), the display reads as shown below. This indicates that the dosimeter has become saturated and must be reset by the appropriate reader / software.

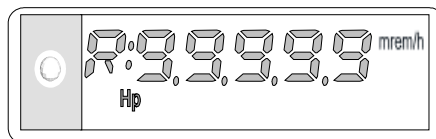

5.2.5. Fault and alarm indicators

In the event of a fault or an alarm, additional messages alternate on the display every 2 seconds (see the example of an alarm below):

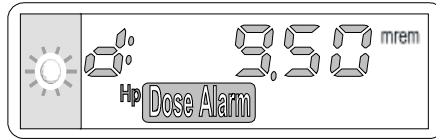

If authorized, the alarm can be acknowledged by pressing the selector button.

Note:

- The alarm messages are described later in Section 7, beginning on page 36.
 - Dosimeter fault messages are described in Section 10, beginning on page 51, which includes a troubleshooting guide.
-

5.2.6. Viewing alarm thresholds

Settings for the alarm and pre-alarm thresholds can be viewed in the *measurement* mode by holding the selector button.

To display the thresholds, press and hold the selector button continuously for at least 10 seconds, **without releasing**. The various thresholds are displayed in succession (every 2 seconds).

When the selector button is released, the current dose equivalent is automatically displayed on the dosimeter.

The threshold display sequence is as follows:

5.2.6.1. Dose alarm threshold display

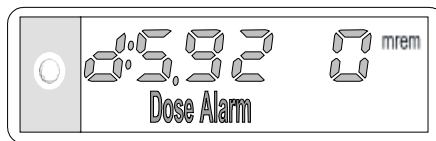

This value corresponds to the alarm threshold of the dose equivalent for the main measurement.

The display is shown in scientific notation.

In the example above, the value of the rate corresponds to 5.92 mRem ($5.92 * 10^0$ mRem)

5.2.6.2. Rate alarm threshold display

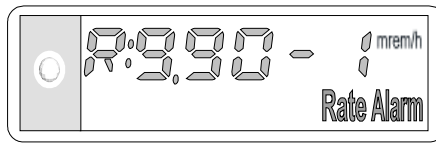

This value corresponds to the alarm threshold of the dose rate for the main measurement.

The display is shown in scientific notation.

In the example above, the value of the rate corresponds to 0.990 mRem/h (9.90×10^{-1} mRem/h)

5.2.6.3. Time alarm threshold display

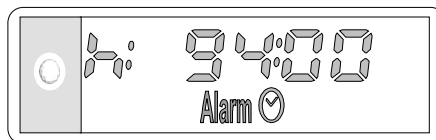

This value corresponds to the length of time alarm threshold (shown here: **94 hours**).

5.2.6.4. Dose pre-alarm warning threshold display

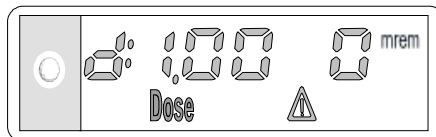

This value corresponds to the pre-alarm threshold of the dose equivalent for the main measurement (shown here: **1 mRem**).

5.2.6.5. Rate pre-alarm warning threshold display

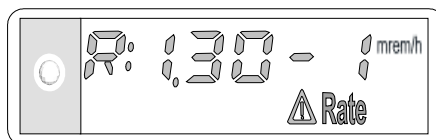

This value corresponds to the pre-alarm threshold of the dose equivalent rate for the main measurement (shown here: **0.130 mRem/h**).

Switching to pause mode

Switching to the *pause* mode implies deactivating the **DMC 2000S** dosimeter. In other words, suppressing the dose measurement functions.

In a centralized dosimetry system, switching to the *pause* mode is accomplished when passing by an LDM 2000 access control monitor.

When switched to the *pause* mode, the display reads as shown below:

- the functional indicators flash
- one of the following messages can be displayed (depending on the dosimeter configuration: assigned or non-assigned...)

- non-assigned dosimeter:

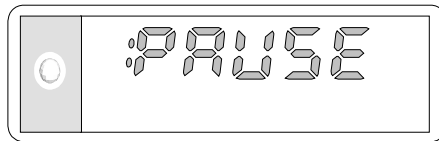

- assigned dosimeter:

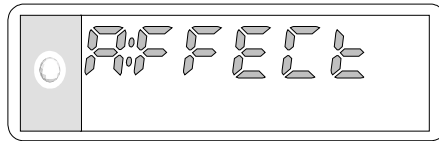

or name of the wearer, depending on the dosimeter configuration

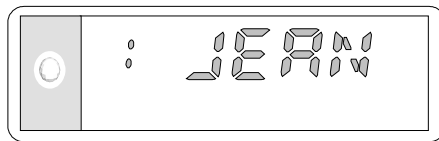

5.3 Operation in the pause mode

5.3.1. Normal display

When the **DMC 2000S** dosimeter is in the pause mode, it continuously performs the operations described on page 10.

The display shows the message “**PAUSE**” or “**affect**” (or *wearer’s name*) is depending on whether or not it is assigned.

- non-assigned dosimeter:

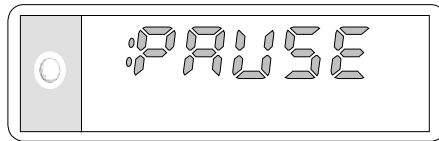

- assigned dosimeter:

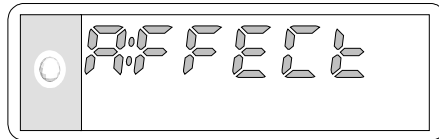

In the event of a fault, additional, alternating messages are displayed every 2 seconds (see the example below):

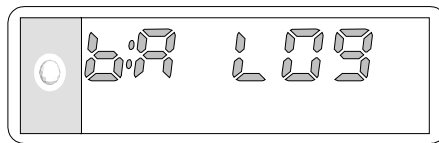

Note: all dosimeter fault messages are described in Section 10, beginning on page 51, which includes a troubleshooting guide.

5.3.2. Operation of the selector button

Using the selector button in the satellite mode allows additional information to be viewed on the **DMC 2000S** dosimeter's display. This data and the corresponding displays are described below. Depending on the dosimeter's configuration, some data can be intentionally concealed.

The different functions of the selector button are listed below:

- pressing the button:
 - displays the next data set
- pressing and holding:
 - maintains the current data on the display
- after 5 seconds without pressing:
 - reverts to normal display in the *pause* mode

The following data is displayed in succession (by pressing the selector button):

5.3.2.1. Dosimeter number display

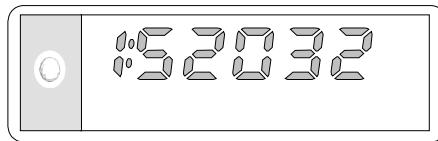

This value corresponds to the identification number specific to the dosimeter.

5.3.2.2. Cumulative dose display

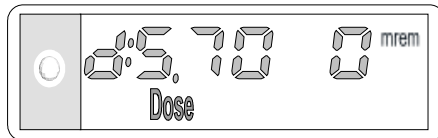

This data corresponds to the cumulative dose equivalent for the main measurement during the last time period in the *measurement* mode (i.e. since the last dose reset to zero, normally performed upon area entry, depending on the centralized dosimetry system's configuration).

The display is shown in scientific notation.

In the example above, the value of the rate corresponds to 5.70 mRem ($5.70 * 10^0$ mRem).

5.3.2.3. Rate display

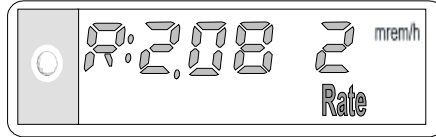

This data corresponds to the maximum dose equivalent rate for the main measurement during the last time period in the *measurement* mode.

The display is shown in scientific notation.

In the example above, the value of the rate corresponds to 208 mRem/h ($2.08 * 10^2$ mRem/h)

5.3.2.4. Time display

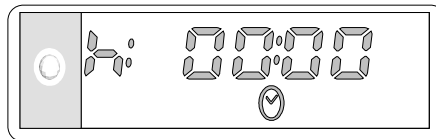

This data corresponds to the duration of the last time period in the *measurement* mode.

5.3.2.5. Dose alarm threshold display

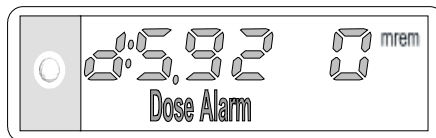

This value corresponds to the alarm threshold of the dose equivalent for the main measurement (shown here: **5.92 mRem**).

5.3.2.6. Rate alarm threshold display

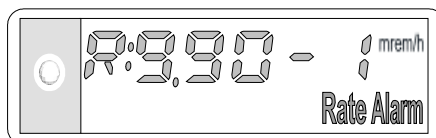

This value corresponds to the alarm threshold of the dose equivalent rate for the main measurement (shown here: **0.990 mRem/h**).

5.3.2.7. Time alarm threshold display

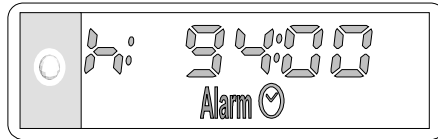

This value corresponds to the time alarm threshold (shown here: **94 hours**).

5.3.2.8. Dose pre-alarm warning threshold display

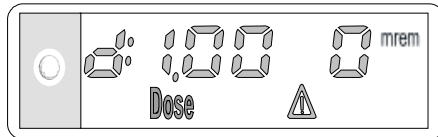

This value corresponds to the pre-alarm threshold of the dose equivalent for the main measurement (shown here: **1 mRem**).

5.3.2.9. Rate pre-alarm warning threshold display

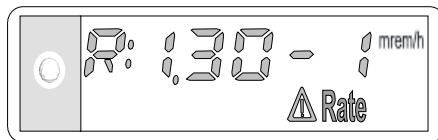

This value corresponds to the pre-alarm threshold of the dose equivalent rate for the main measurement (shown here: **0.130 mRem/h**).

5.3.2.10. Audible alarm operating mode display

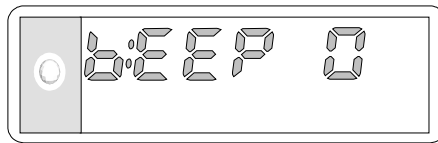

This value corresponds to the function, which indicates the ambient rate to the user by an audible signal, which is independent of the display:

- “**BEEP.0** ”: no audible signal for dose increments
- “**BEEP.1** ”: 1 beep every 10 mRem (100 μ Sv)
- “**BEEP.2** ”: 1 beep every 1 mRem (10 μ Sv),
- “**BEEP.3** ”: 1 beep every 0.1 mRem (1 μ Sv),
- “**BEEP.4** ”: 1 beep every 8 pulses (1 beep / sec per 26.7 mRem or 267 μ Sv)
- “**BEEP.5** ”: 1 beep every 4 pulses (1 beep / sec per 13.3 mRem or 133 μ Sv)

5.3.2.11. Operating mode display

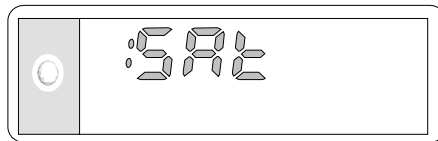

The message “**Sat** ” indicates that the dosimeter is configured for **Satellite Mode**, (i.e. for use in a centralized dosimetry system).

5.3.2.12. Optional external probe number display

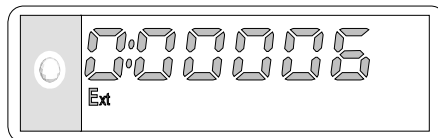

This value corresponds to the identification number specific to the optional extremity probe, if the external extremity probe is connected. The message “**FFFFFF** ” indicates that the dosimeter does not have an extremity probe connected.

5.4 “Pass-by” reading

This “pass-by” reading allows dosimeter information to be transmitted to the centralization system by simply passing by an **LDM 2000** reader.

At a minimum, the following information is transmitted:

- the dosimeter’s number
- the cumulative dose equivalent
- any recorded alarm or fault information

6. Operation in the autonomous mode

6.1 Switching to the measurement mode

Switching to the *measurement* mode implies activating the **DMC 2000S** dosimeter. In other words, programming the dose equivalent measurement.

It is performed from the **pause** mode, as explained below.

- the display as it appears in the *pause* mode is shown below:

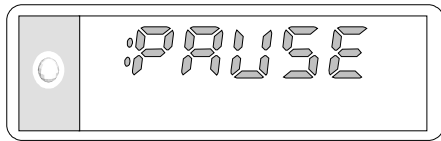

The flashing colon on the display indicates the dosimeter is functioning.

- the following message is displayed when the selector button is pressed:

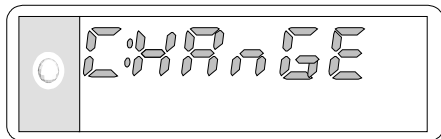

- after approximately 3 seconds, the following message is displayed:

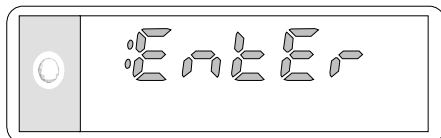

- while this message is displayed, press and immediately release the selector button
- NOTE: the above message is displayed for less than two seconds
- if successful, the following message appears briefly on the display:

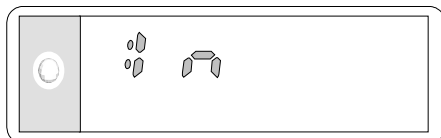

- Along with this message, the dosimeter audibly “beeps,” the red LED flashes” and a display test is performed, which activates all segments of the LCD display.

The dosimeter is now operational (*measurement* mode):

- the functional indicators are flashing
- The dose value appears on the display. The unit, format (fixed or floating point) and display resolution are selected during dosimeter configuration.

Example of a display:

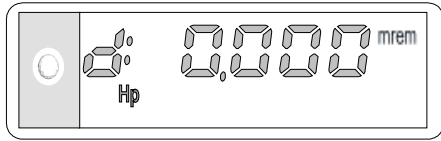

6.2 Operation in the measurement mode

6.2.1. Displaying the dose equivalent measurement

When in the measurement mode, the **DMC 2000S** dosimeter continuously measures the Hp (10) dose equivalent, as well as performing other operations (see section 2.2.3, *Measurement mode*, page 10).

The display shows the dose value. The unit, format (fixed or floating point) and display resolution are selected during dosimeter configuration.

Example of a display:

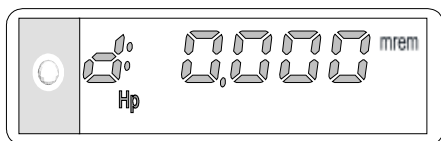

6.2.2. Dose equivalent saturation

When the dose equivalent exceeds the value 999.9999 rem (99999.99 mSv), the display reads as shown below:

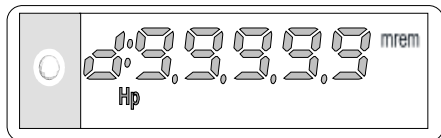

6.2.3. Displaying the dose rate measurement

Pressing and immediately releasing the selector button displays the dose rate value for 30 seconds. The unit, format (fixed or floating point) and display resolution are selected during dosimeter configuration.

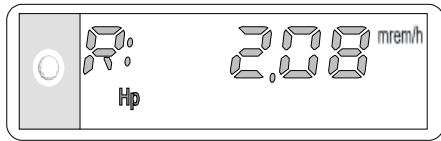

After this 30 seconds, the dose equivalent value is then displayed again:

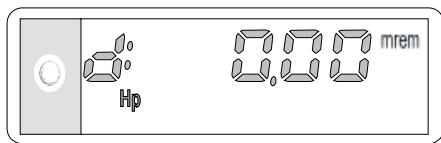

Note: The DMC 2000S may be configured to display other combinations of dose / rate, using DOSIMASS software. Please contact MGPI for details.

6.2.4. Dose rate saturation

When the dose rate exceeds the value 9999 mSv/h (999.9 rem/h), the display reads as shown below:

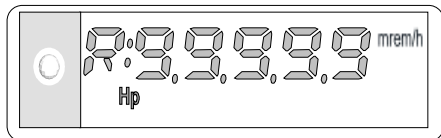

6.2.5. Fault and alarm indicators

In the event of a fault or an alarm, additional messages alternate on the display every 2 seconds (see the example of an alarm below):

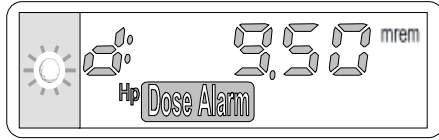

If the user is authorized (by previous configuration of the dosimeter), they may acknowledge the alarm by pressing the selector button.

Note:

- The alarm messages are described later in Section 7, beginning on page 36.
 - Dosimeter fault messages are described in Section 10, beginning on page 51, which includes a troubleshooting guide.
-

6.2.6. Viewing alarm thresholds

Settings for the alarm and pre-alarm thresholds can be viewed in the *measurement* mode by using the selector button.

To display the thresholds, press and hold the selector button for at least 10 seconds, **without releasing** while the thresholds are alternately displayed (every 2 seconds).

When the selector button is released, the dose equivalent is automatically displayed on the dosimeter.

The threshold display sequence is as follows:

- After approximately 10 seconds, the following 3 messages are displayed. To avoid inadvertently switching to *pause* mode, **do not release the selector button**:

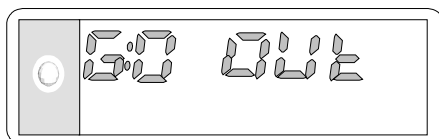
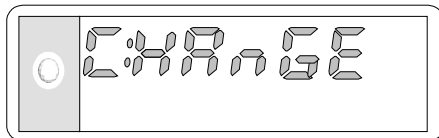

- the following thresholds are then displayed:

6.2.6.1. Dose alarm threshold display



This value corresponds to the alarm threshold of the dose equivalent for the main measurement.

The display is shown in scientific notation.

In the example above, the value of the rate corresponds to 5.92 mRem ($5.92 * 10^0$ mRem).

6.2.6.2. Rate alarm threshold display

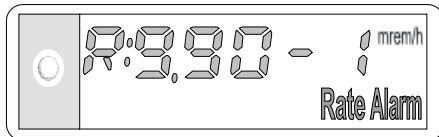

This value corresponds to the alarm threshold of the dose rate for the main measurement.

The display is shown in scientific notation.

In the example above, the value of the rate corresponds to 0.990 mRem/h ($9.90 * 10^{-1}$ mRem/h).

6.2.6.3. Dose pre-alarm warning threshold display

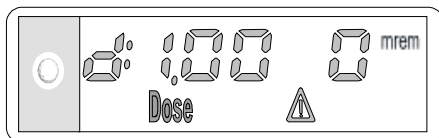

This value corresponds to the pre-alarm threshold of the dose equivalent for the main measurement (shown here: **1 mRem**).

6.2.6.4. Rate pre-alarm warning threshold display

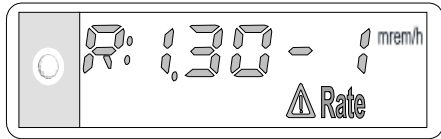

This value corresponds to the pre-alarm threshold of the dose rate for the main measurement (shown here: **0.130 mRem/h**).

6.3 Switching to pause mode

Switching to the *pause* mode implies deactivating the **DMC 2000S** dosimeter. In other words, suppressing the dose equivalent measurement.

To switch to the *pause* mode when using the DMC 2000S in the autonomous mode, press the selector button and follow the procedure listed below:

- The selector button should be held pressed in for approximately 10 seconds. The following messages are displayed in succession:

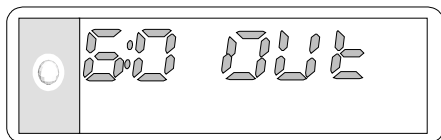
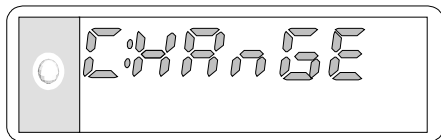

- When this “go out” message is displayed, **immediately** release the selector button. The following message is displayed briefly:

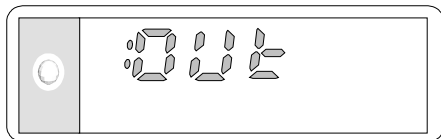

The dosimeter is now in the *pause* mode. The display indicates the following:

- the functional indicators are flashing
- one of the following messages can be displayed (depending on the dosimeter configuration: assigned or non-assigned, etc.):

- non-assigned dosimeter:

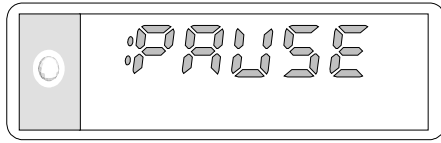

- assigned dosimeter:

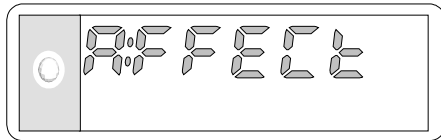

or name of the wearer, depending on the dosimeter configuration

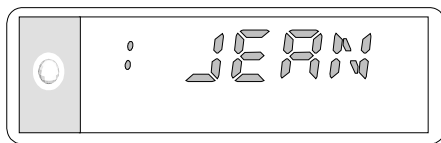

6.4 Operation in the pause mode

6.4.1. Normal display

When the **DMC 2000S** dosimeter is in the pause mode, it continuously performs the operations described in section 2.2.2, page 10.

Switching to this mode requires the use of a centralized dosimetry system.

The display shows the message “*PAUSE*” or “*affect*” (or *wearer’s name*), depending on whether or not it has been assigned to a specific user.

- non-assigned dosimeter:

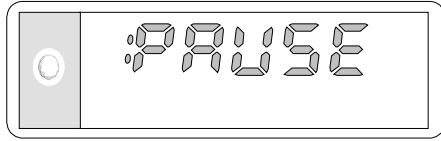

- assigned dosimeter:

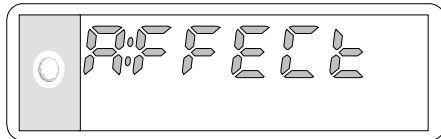

In the event of a fault, additional, alternating messages are shown on the display every two seconds (see the example below):

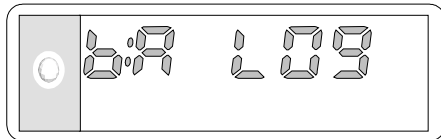

Note: all dosimeter fault messages are described in Section 10, beginning on page 51, which includes a troubleshooting guide.

6.4.2. Operation of the selector button

When in the **autonomous mode**, the following operations can be performed by using the selector button:

- activation and deactivation of the **DMC 2000S** dosimeter (switch from *pause* mode to the *measurement* mode and vice versa)
- viewing of necessary information on the **DMC 2000S** dosimeter display
- modification of the alarm thresholds when necessary

This information is described below, and includes the corresponding displays. Depending on the dosimeter configuration, some data can be intentionally concealed.

The different functions of the selector button are listed below:

- pressing the button:
 - displays the next data
- pressing and holding:
 - maintains the data on the display
- after 5 seconds without pressing:
 - normal display in the *pause* mode

The following data is displayed in succession (by pressing the selector button):

6.4.2.1. Dosimeter activation

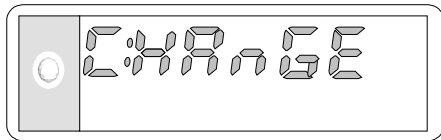

This message indicates that the dosimeter can now be activated (see section *Modifying parameters*, page 45)

6.4.2.2. Parameter modification

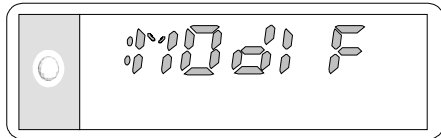

This message indicates that some parameters can be accessed for modification (see section *Modifying parameters*, page 45)

6.4.2.3. Operating mode display

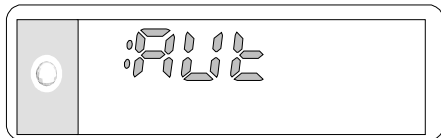

The message “*Aut*” indicates that the dosimeter is configured for use in the autonomous mode.

6.4.2.4. Dose recording mode display

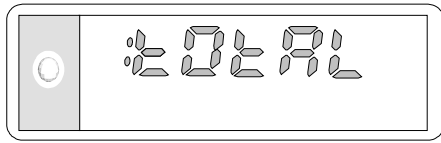

The message “*total*” indicates that the dosimeter accumulates the dose equivalent values at the end of each dosimeter use.

Or

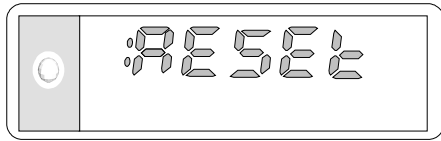

The message “*reset*” indicates that the dosimeter resets to zero each time it is switched to the *measurement* mode.

6.4.2.5. Cumulative dose display

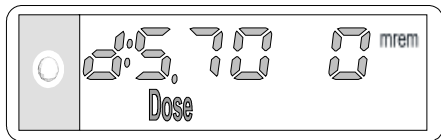

This data corresponds to the cumulative dose equivalent for the main measurement during the last time period in the *measurement* mode (since the last dose was reset to zero, which is normally performed upon area entry, depending on the centralized dosimetry system’s configuration).

The display is shown in scientific notation.

In the example above, the value of the rate corresponds to 5.70 mRem ($5.70 * 10^0$ mRem).

6.4.2.6. Rate display

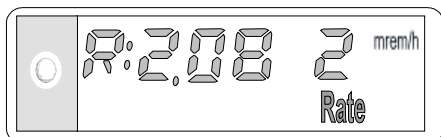

This data corresponds to the maximum dose rate for the main measurement during the last time period in the *measurement* mode.

The display is shown in scientific notation.

In the example above, the value of the rate corresponds to 208 mRem/h ($2.08 * 10^2$ mRem/h)

6.4.2.7. Time display (Watch/Clock)

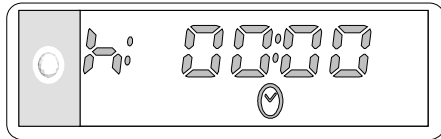

This is configured using DOSIMASS or Access Control software for a live time ‘Watch/Clock’ feature (this feature can be ON or OFF). This feature is only available DMC 2000 dosimeters with firmware version 2.6 or higher.

6.4.2.8. Dose alarm threshold display

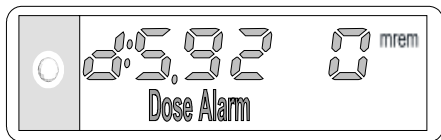

This value corresponds to the alarm threshold of the dose equivalent for the main measurement (shown here: **5.92 mRem**).

6.4.2.9. Rate alarm threshold display

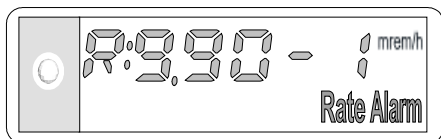

This value corresponds to the alarm threshold of the dose rate for the main measurement (shown here: **0.990 mRem/h**).

6.4.2.10. Dose pre-alarm warning threshold display

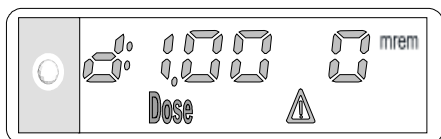

This value corresponds to the pre-alarm threshold of the dose equivalent for the main measurement (shown here: **1 mRem**).

6.4.2.11. Rate pre-alarm warning threshold display

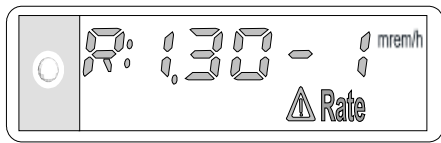

This value corresponds to the pre-alarm threshold of the dose equivalent rate for the main measurement (shown here: **0.130 mSv/h**).

6.4.2.12. Audible alarm operating mode display

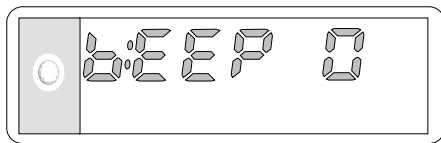

This value corresponds to the function, which indicates the ambient rate to the User by an audible signal, which is independent of the display:

- “ **BEEP.0** ” : no audible signal for dose increments
- “ **BEEP.1** ” : 1 beep every 10 mRem (100 μ Sv)
- “ **BEEP.2** ” : 1 beep every 1 mRem (10 μ Sv)
- “ **BEEP.3** ” : 1 beep every 0.1 mRem (1 μ Sv)
- “ **BEEP.4** ” : 1 beep every 8 pulses (1 beep / sec per approx. 26.7 mRem or 267 μ Sv)
- “ **BEEP.5** ” : 1 beep every 4 pulses (1 beep / sec per approx. 13.3 mRem or 133 μ Sv)

6.4.2.13. Dosimeter number display

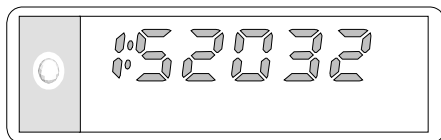

This value corresponds to the identification number specific to the dosimeter.

6.4.2.14. Exercise Mode

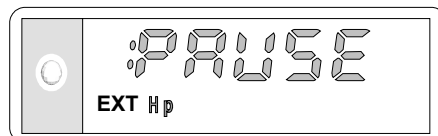
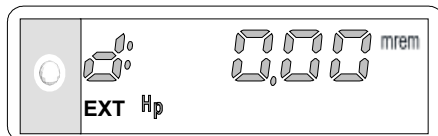

The **EXT** mode is for training mode and will not accumulate dose with ionizing radiation in this mode. This feature is only available in dosimeters with firmware version 2.6 or greater. **Contact MGP Instruments concerning the use of this feature.**

6.4.2.15. Optional external probe number display

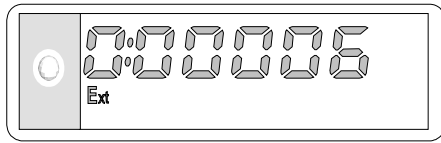

This value corresponds to the identification number specific to the optional extremity probe, if the external extremity probe is connected.

The message “*FFFFFF*” indicates that the dosimeter does not have an extremity probe connected.

7. Alarms

The **DMC 2000S** dosimeter generates audible and visual alarms when threshold levels, which have been pre-set during configuration, are exceeded. In the *measurement* mode these alarm indicators are:

- an audible alarm emitted by the dosimeter buzzer
- a flashing message or symbol on the display
- 3 flashes (short flashes by the indicator light) emitted during the alarm, at a rate of 3 quick light flashes per second (if the dosimeter has been configured with this function)

Notes:

- *in the event of simultaneous alarms, all corresponding messages and symbols are displayed*
 - *The audible alarms and alarm displays can be disabled when configuring the **DMC 2000S**; this function can be configured at the factory or modified using the **DOSIMASS** maintenance software or the **DOSIVIEW** access control software, in conjunction with the **LDM 2000** reader.*
-

7.1.1. Dose pre-alarm

- cause:
 - pre-alarm threshold for dose equivalent exceeded
- audible alarm (see below):

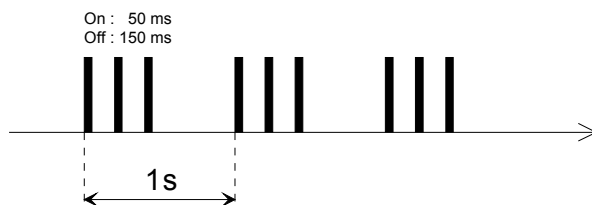

- display:
 - the message “*Dose*” and the “warning” symbol flash. The dose is still displayed (see below) :

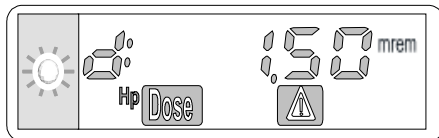

- Acknowledgment: this silences the alarm, but does not change the display.
 - to acknowledge the dose pre-alarm, press and hold the selector button for at least 3 seconds.

7.1.2. Rate pre-alarm

- cause (only in the *measurement* mode):
 - pre-alarm threshold for the dose rate exceeded
- audible alarm (see below):

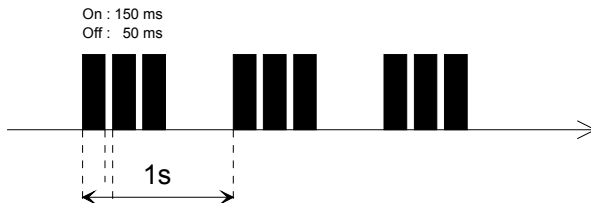

- display:
 - the message “Rate” and the “warning” symbol flash. The dose is still displayed (see below):

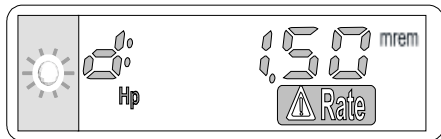

- acknowledgment: this silences the alarm, but does not change the display
 - To acknowledge the dose pre-alarm, press and hold the selector button for at least 3 seconds.

Note:

In the event that a rate pre-alarm occurs at the same time as a pre-alarm or a dose alarm, the audible alarm indication is as follows:

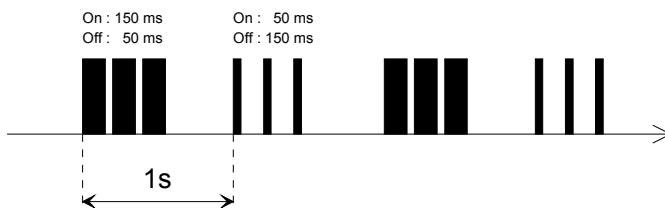

7.1.3. Dose alarm

- cause (only in the *measurement* mode):
 - dose equivalent alarm threshold exceeded
- audible alarm (see below):

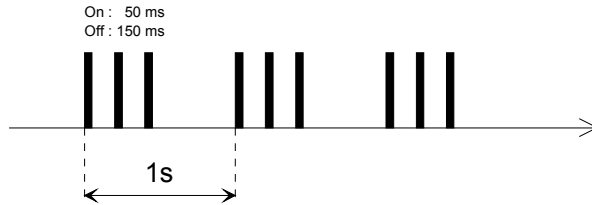

- display:
 - the message “ *Dose Alarm* ” flashes. The dose is still displayed (see below):

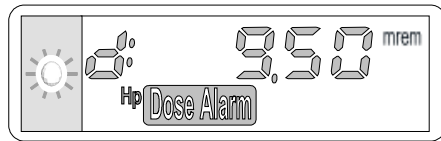

Note: the dose alarm cannot be silenced via acknowledgement.

7.1.4. Dose rate alarm

- cause (only in the *measurement* mode):
 - dose rate alarm threshold exceeded
- audible alarm (see below):

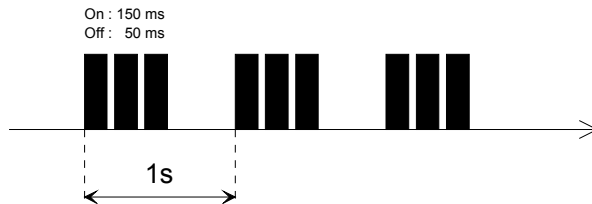

In the event that a rate alarm occurs at the same time as a pre-alarm or a dose alarm, the audible alarm indication is as follows:

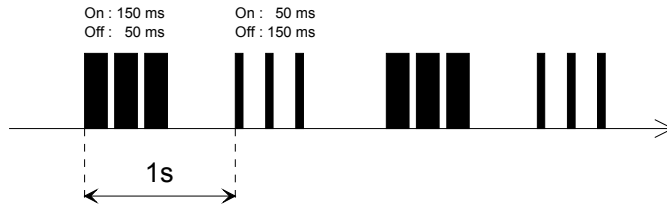

- display:
- the message “ *Rate Alarm* ” flashes. The dose is still displayed (see below):

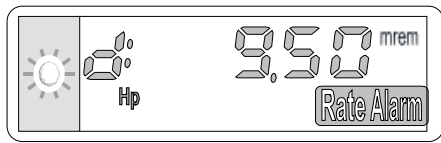

Note:

- *the dose rate alarm cannot be silenced via acknowledgement.*
 - *in the standard configuration the dose rate alarm is suppressed by setting the alarm threshold to the measurement range’s high value.*
-

7.1.5. Time alarm

- cause:
- alarm threshold exceeded

Audible alarm: one beep every second

- display:
- the message “ *CLOC* ” and the measurement alternate on the display (see below) :

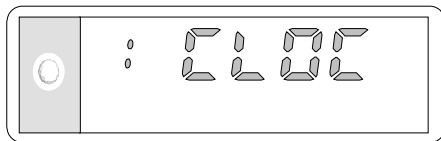

Note:

- *the time alarm threshold be programmed at the factory or by using the LDM 2000 or LDM 101 dosimeter reader and the DOSIMASS maintenance software.*
 - *this threshold cannot be adjusted in the autonomous mode.*
-

8. Setting operating parameters

8.1 In the satellite mode

When the DMC 2000S is in the Satellite mode, all operating parameters can be modified.

Modifying parameters in this mode requires the use of an LDM 2000 or LDM 101 reader connected to MGPAC, the centralized dosimeter software, or DOSIMASS, the dosimeter maintenance software.

8.2 In the autonomous mode

When the DMC 2000S is in the Autonomous mode, the user can directly modify the main operating parameters by simply using the selector button. No other equipment is required. This can only be accomplished while the dosimeter is in the *pause* mode.

8.3 Modifiable parameters

The parameters which can be modified are described below in the order in which they appear on the display when the selector button is pressed. However, depending on the dosimeter configuration, some parameters may not be displayed.

8.3.1.1. Cumulative dose

modifiable in both the satellite (with an LDM-101 or LDM 2000 and the appropriate software) and autonomous modes

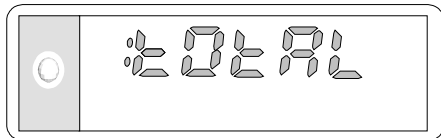

Or

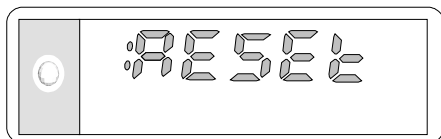

This parameter configures the absorbed dose to be cumulative or reset to zero during each usage period.

- The message “*total*” indicates that the dosimeter is accumulating the dose equivalent values after each use of the dosimeter.
- The message “*reset*” indicates that the dosimeter resets to zero each time it is switched into the *measurement* mode.

8.3.1.2. Dose alarm threshold

modifiable in both the satellite (with an LDM-101 or LDM 2000 and the appropriate software) and autonomous modes

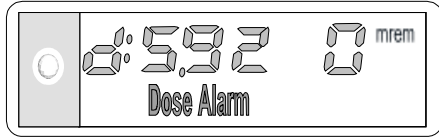

This parameter corresponds to the dose equivalent value above which an alarm will be triggered.

This value can be set from $1.0 * 10^{-1}$ to $9.99 * 10^{+5}$ mRem.

8.3.1.3. Rate alarm threshold

modifiable in both the satellite (with an LDM-101 or LDM 2000 and the appropriate software) and autonomous modes

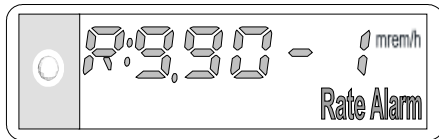

This parameter corresponds to the dose rate value above which an alarm will be triggered.

This value can be set from $1.0 * 10^{-1}$ to $9.99 * 10^{+5}$ mRem.

8.3.1.4. Time alarm threshold

modifiable only in the satellite mode, with an LDM-101 or LDM 2000 and the appropriate software

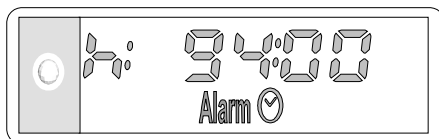

This parameter corresponds to the time period operating in the **measurement** mode after which an alarm will be triggered.

This value can be set from 0-hr. 01 min. to 99-hr. 59 min.

If this value is set to **00 hr. 00**, the **time** alarm will not be triggered.

8.3.1.5. Dose pre-alarm warning threshold

modifiable in both the satellite (with an LDM-101 or LDM 2000 and the appropriate software) and autonomous modes

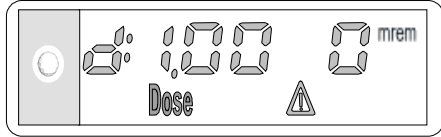

This parameter corresponds to the dose equivalent value above which a pre-alarm will be triggered.

This value can be set from $1.0 * 10^{-1}$ to $9.99 * 10^{+5}$ mRem; it should always be lower than the dose equivalent alarm threshold.

If this value is set to **0 (0.00.10⁰)**, the *dose* pre-alarm will not be triggered.

8.3.1.6. Rate pre-alarm warning threshold

modifiable in both the satellite (with an LDM-101 or LDM 2000 and the appropriate software) and autonomous modes

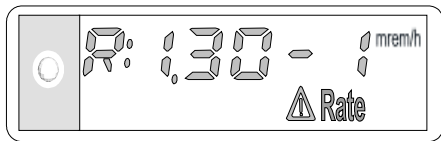

This parameter corresponds to the dose rate value above which a pre-alarm will be triggered.

This value can be set from $1.0 * 10^{-1}$ to $9.99 * 10^{+5}$ mRem; it should always be lower than the dose rate alarm threshold.

If this value is set to **0 (0.00.10⁰)**, the *rate* pre-alarm will not be triggered.

8.3.1.7. Audible alarm indications

modifiable only in the satellite mode, with an LDM-101 or LDM 2000 and the appropriate software

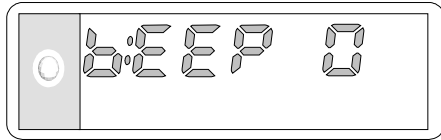

This parameter provides an indication of the ambient rate to the User by an audible signal, which is independent of the display.

- “ **BEEP.0** ” : no audible signal for dose increments
- “ **BEEP.1** ” : 1 beep every 10 mRem (100 μ Sv)
- “ **BEEP.2** ” : 1 beep every 1 mRem (10 μ Sv)
- “ **BEEP.3** ” : 1 beep every 0.1 mRem (1 μ Sv)
- “ **BEEP.4** ” : 1 beep every 8 pulses (1 beep / sec per approx. 26.7 mRem or 267 μ Sv)
- “ **BEEP.5** ” : 1 beep every 4 pulses (1 beep / sec per approx. 13.3 mRem or 133 μ Sv)

8.3.1.8. “Emergency start-up” operating mode

modifiable in both the satellite (with an LDM-101 or LDM 2000 and the appropriate software) and autonomous modes

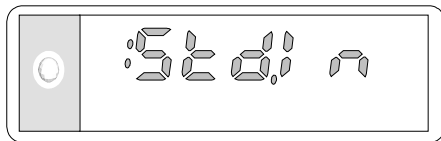

or

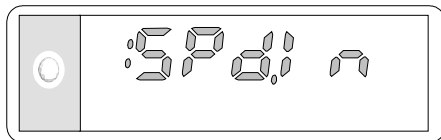

The **emergency start-up** mode can be activated with this parameter.

- the message “ **Std.In** ” indicates that the **emergency start-up** mode is disabled (“Standard In”).
- the message “ **SPd.In** ” indicates that the **emergency start-up** mode is enabled (“SPeed In”).

Note: after each emergency start-up, that mode is disabled. (For further information on this operating mode, refer to the section Emergency start-up, page 49).

8.4 Modifying parameters

In the *autonomous* mode, the user can modify the various operating parameters of the DMC 2000S dosimeter by using the selector button.

Reminder: in the satellite mode, all parameter modifications require the Use of an LDM 2000 reader and centralized dosimeter system software.

8.4.1. Accessing the modification mode

This is accomplished by following the procedure described below. Begin in the *pause* mode.

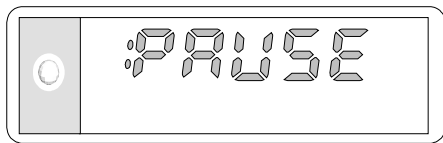

Press and release the selector button once and the display changes to:

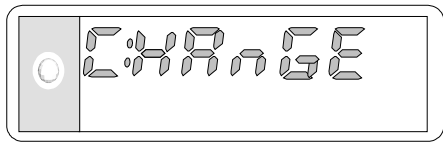

Press and release the selector button a second time and the DMC 2000S dosimeter is now in the *parameter modification* mode.

First, the message below will be displayed for a few seconds.

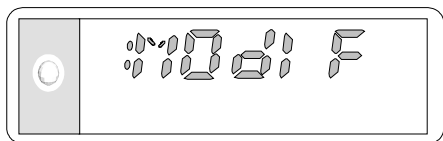

then the following message is displayed:

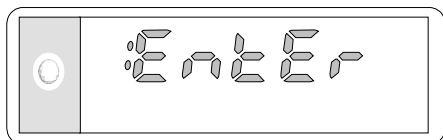

When this message is displayed, **immediately** press the selector button to access the parameters to be modified.

The following message is displayed:

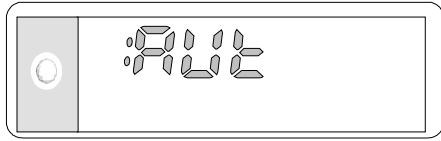

The modifiable parameters can now be accessed by simply pressing and releasing the selector button.

The parameters are then displayed in the order as outlined in the section *Modifiable parameters*, page 40.

8.4.2. Procedures for modifying parameters

Parameter modification is performed in the *modification* mode. The preceding section describes how to access this mode.

The procedure is the same for all modifiable parameters

There are three steps in setting parameters:

8.4.2.1. Step “ P ”

The flashing “P” displayed to the left of the “functional indicators” identifies this step. It allows all modifiable **parameters** to be accessed.

- pressing and releasing enters the current parameter and takes you to the next one
- pressing and holding the selector button takes you to the next step

8.4.2.2. Step “d”

This step is identified by the flashing “d” displayed to the left of the “functional indicators”. It allows you to access each **digit** of the current parameter.

- pressing and releasing allows you to access the next digit
- pressing and holding the selector button takes you to the next step

Note: this step is not included for the “general” parameters such as “RESET” or “TOTAL”.

8.4.2.3. Step “ I ”

The flashing “I” displayed to the left of the “functional indicators” identifies this step. It allows modification of the selected digit of the current parameter by **increments**.

- pressing and releasing changes the value by 1 increment
- pressing and holding the selector button takes you to the next step

Note: for “general” parameters, pressing and releasing the selector button allows selection of the available values (for example: “RESET “ or “TOTAL”)

Steps “ I ” and “d” are displayed after step “ P ”, but not in any particular order.

The DMC 2000S dosimeter automatically switches back to the *pause* mode after 10 seconds of inactivity on the selector button.

8.4.3. Example for setting parameters

- access the *modification* mode as described in the section *Accessing the modification mode*, page 44.
- **go to the parameter you want to modify:**
 - by successively pressing and releasing the selector button

example shown: dose alarm threshold

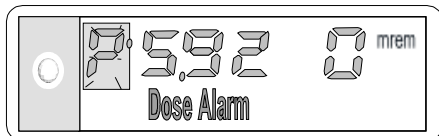

the parameter is displayed and is preceded by a flashing “ P ” (parameter setting mode is active)

- **to access** the digit you want to change:
 - press and hold the selector button until the flashing “d” is displayed (the digit which can be changed is flashing)
 - press and release the selector button until the digit you want to change is flashing

in the example shown, the digit to be modified flashes as soon as the “d” is displayed:

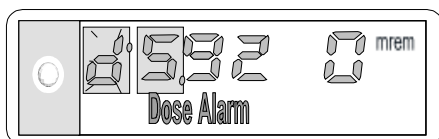

- **to change** the value of the selected digit

- press and hold the selector button until the flashing “ I ” is displayed

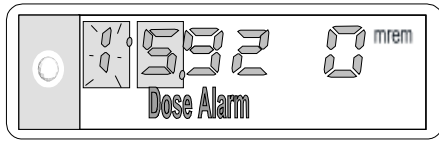

- increment the digit to the desired value by pressing and releasing the selector button until this value is reached

in the example shown, the selector button must be pressed 4 times in order to obtain the value “9” :

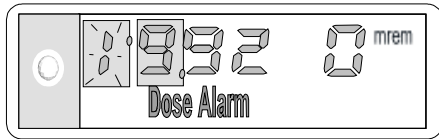

■ **to access** the next digit:

- press and hold the selector button until the flashing “ d ” is displayed
- access the other digits you want to change by pressing and releasing the selector button

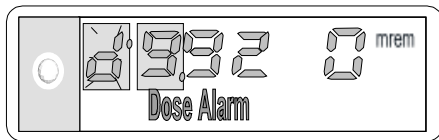

in the example shown, the selector button must be pressed 3 times to access the exponent:

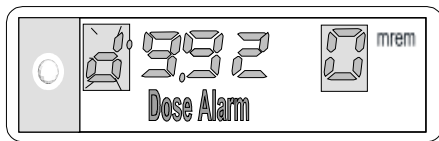

■ **to change** the value of the newly selected digit:

- press and hold the selector button until the flashing “ I ” is displayed
- increment the digit to the desired value by pressing and releasing the selector button until this value is reached

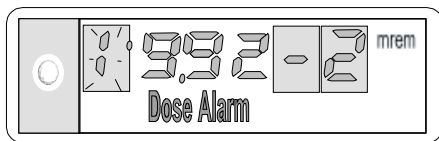

in the example shown, the selector button must be pressed 4 times in order to obtain the value “-2” :

- **validating** the new values:
 - press and hold the selector button until the flashing “ P ” is displayed

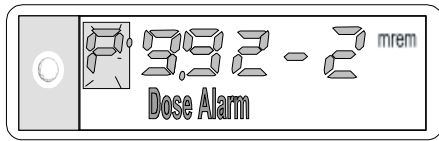

- **modifying** other parameters:
 - press and release the selector button to access the next parameter to be modified
 - repeat the steps as described above for the “dose alarm” parameter
- return to the *pause* mode:
 - wait approximately 10 seconds before using the selector button. The dosimeter automatically returns to the *pause* mode.

9. Other functions

9.1 Emergency start-up

The DMC 2000S dosimeter's start-up functionality can be accomplished using a simplified and quick procedure.

For this function, the “*emergency start-up*” operating mode must be enabled (refer to the section *Setting operating parameters*, section “*Emergency start-up*”, page 43).

When the “*emergency start-up*” operating mode is enabled, the following message is continuously displayed:

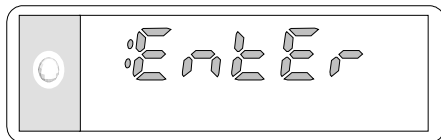

Simply pressing once on the selector button immediately switches the DMC 2000S dosimeter to the *measurement* mode:

The following message is displayed briefly:

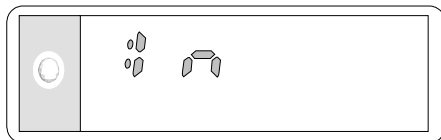

then the dosimeter switches to the *measurement* mode:

- the “functional indicator” is flashing
- the display indicates the value of the dose

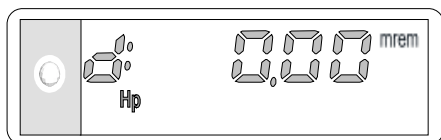

Note: as soon as the dosimeter switches back to the pause mode, the “*emergency start-up*” operating mode is disabled. To enable this mode again, the parameters must also be set again. (Refer to the section *Setting operating parameters*, section “*Emergency start-up*”, page 43).

9.2 Historical

The **DMC 2000S** dosimeter has a “historical” function, which allows:

- recording and storage of the change in the cumulative dose by intervals (750 historical intervals of 10 s, 1 min. 10 min. 1 hr or 24 hr depending on the dosimeter’s configuration)
- recording and dating of significant events such as:
 - alarms, pre-alarms
 - acknowledgment of pre-alarms
 - assignment and storage of identifier code
 - task code
 - change in operating mode (*pause* and *measurement*)
 - dosimeter fault
 - saturation
- dating of the last assignment change

In order to provide this function, the **DMC 2000S** dosimeter is equipped with internal clock functionality, which is set during configuration (refer to the centralized dosimetry system User’s manual).

10. Faults

This section includes a troubleshooting guide, which describes the dosimeter fault messages. Dosimeter faults are indicated by:

- an audible signal emitted by the dosimeter buzzer
- display of the current message, alternating with a fault message every 2 seconds, and lasting 2 seconds

10.1.1. Battery low

- most likely cause:
 - battery discharged; the remaining battery life in the *measurement* mode is 10 hours
- 3 audible pulses every 10 minutes:

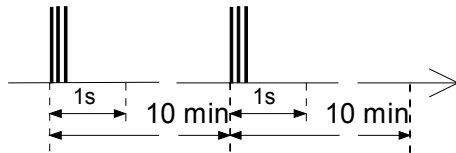

- display:
 - if the dosimeter is in the *measurement* mode, the message “BA LOX” alternates on the display with the normal message (with X = number of remaining battery life hours, between 0 and 9):

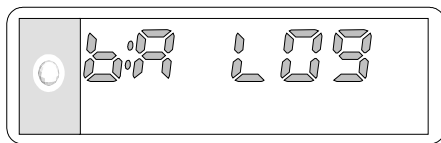

- if the dosimeter is in the *pause* mode, the message “BA LO” alternates on the display with the normal message. This message is displayed for 72 hours, then the dosimeter automatically switches to a reduced consumption mode, during which all functions cease.

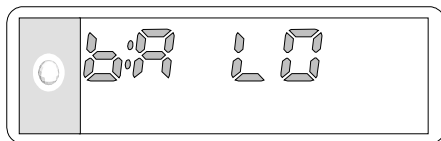

In this mode, the remaining battery life is not indicated.

- corrective action:
 - change the battery

10.1.2. “Defective” battery

- most likely cause:
 - battery totally discharged or battery removed
- 3 audible pulses every 10 seconds:

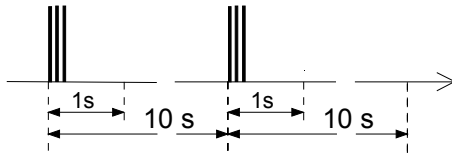

- display:
 - the display reads “*DF BAT*” and the “functional indicators” are no longer present

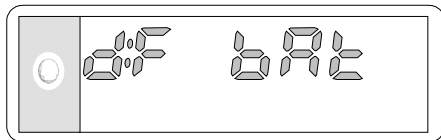

- the dosimeter completely stops after 3 minutes. The audible pulses cease and the display goes blank.

However, all data (parameters, dose, operating time, histogram, etc.) is saved in the E2PROM memory and can be accessed once the battery is replaced.

- corrective action:
 - change the battery

10.1.3. Historical fault

- most likely cause:
 - problem in the integrity of the historical data. This can occur after the battery has been handled (removed or changed).

- display:
 - the display reads “*DF HIS*”

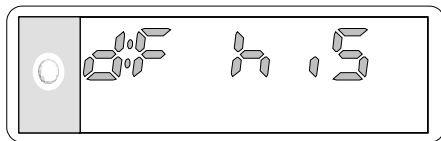

- corrective action:
 - activate the dosimeter with historical initialization (making sure to have previously deactivated it)

10.1.4. Calibration fault

- most likely cause:
 - problem in the integrity of dosimeter data

- display:
 - the display reads “ *DF CAL* ”

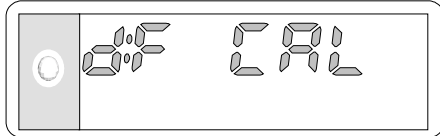

- corrective action:
 - re-calibrate the dosimeter

10.1.4.1.1. Calibration Mode

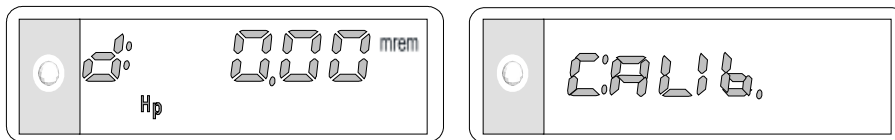

The **Calibration** mode is for factory calibration and will not accumulate dose with ionizing radiation in this mode. This feature is only available in dosimeters with firmware version 2.6 or greater. **Contact MGP Instruments concerning the use of this feature.**

10.1.5. Detector fault

- most likely cause:
 - physical, internal problem related to the dosimeter's detection circuit
- 2 audible pulses every second (only if the dosimeter is in the *measurement* mode):

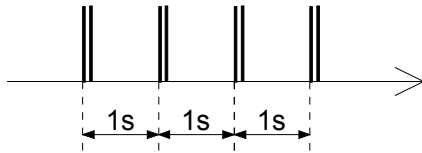

- display:
 - the display reads “*DF DET*”

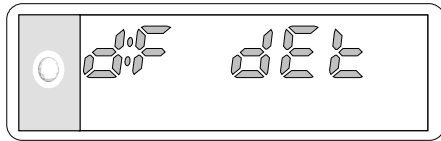

- corrective action:
 - return dosimeter to MGP Instruments

10.1.6. E2PROM fault

- most likely cause:
 - problem accessing data saved in E2PROM memory
- display:
 - the display reads “ *DF E2P* ”.

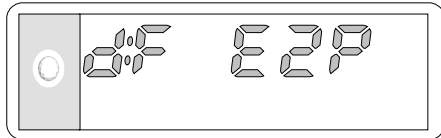

- corrective action:
 - remove the battery and then reinstall the battery
 - if the fault persists, return the dosimeter to MGP Instruments.

10.1.7. Initialization fault

- most likely cause:
 - dosimeter data integrity problem
- display:
 - the display reads “ *DF INT* ”.

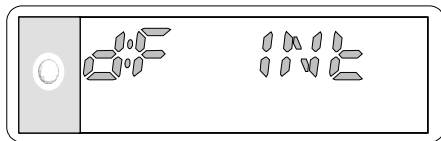

- corrective action:
 - re-initialize the dosimeter Integrated circuit fault

10.1.8. Integrated circuit fault

- most likely cause:
 - fault in the component used for the nuclear pulse count
- display:
 - the display reads “ *DF CId* ”.

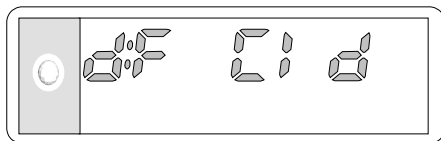

- corrective action:
 - return the dosimeter to MGP Instruments

11. Maintenance

11.1 Changing the battery

To change the dosimeter Renata battery, follow the steps below.

- Using the tool provided (or if unavailable, using a screwdriver), unscrew (counterclockwise) the battery cover shown below:

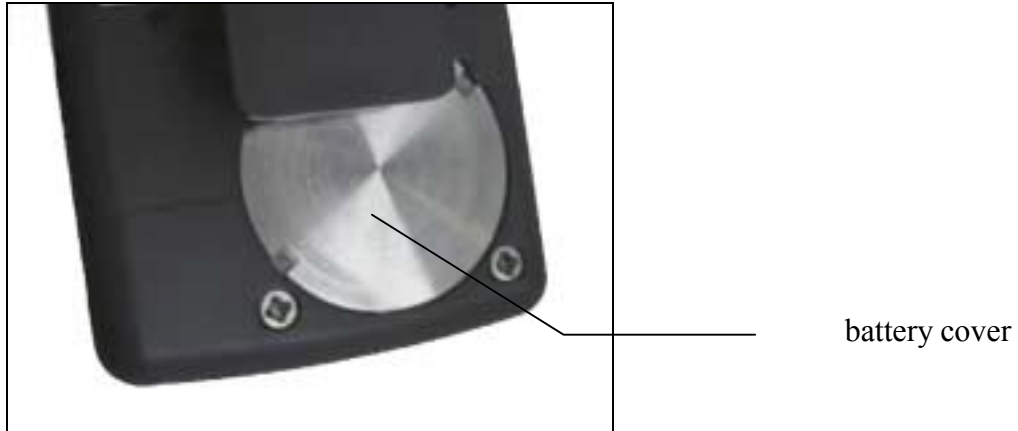

- **Remove the battery cover and remove the battery**



- insert a new Renata battery in the housing (with the “ + ” side of the battery placed towards the back of the dosimeter)



- replace (clockwise) the battery cover back on using the key.

When the battery is removed, the “defective” battery alarm (i.e. *DF BAT*) is triggered.

12. Technical characteristics

12.1 Physical characteristics

- radiation detected:
 - X-rays and gamma fields with energies from 60 keV to 6 MeV

- quantity measured:
 - individual dose equivalent Hp (10)
 - the corresponding dose rate

- measurement range:
 - dose equivalent: from background to 1000 Rem (10 Sv)
 - dose equivalent rate: from background to 1000 Rem/hr (10 Sv/h)

- display range:
 - dose equivalent: 0.1 mRem to 100 Rem (10^{-6} to 10 Sv)
 - dose rate: 1 mRem/hr to 100 Rem/hr (10^{-5} to 10 Sv/h)

- measurement error:
 - dose equivalent: better than $\pm 20\%$ over the entire measurement range
 - dose rate:
 - better than $\pm 30\%$ from 50 to 500 mRem/hr
 - better than $\pm 20\%$ from 500 mRem/hr to 1000 Rem/hr

- energy response:
 - better than $\pm 30\%$ from 60 keV to 2 MeV (reference ^{137}Cs)
 - better than $+100\% - 50\%$ from 2 MeV to 12 MeV (reference ^{137}Cs)

- isotropic: better than $\pm 20\%$ with ^{137}Cs and better than $\pm 50\%$ with X-rays filtered 60 keV in relation to the conventionally established deviations (IEC 1283) for angles between $\pm 75^\circ$.

12.1.1. Isotropic graph

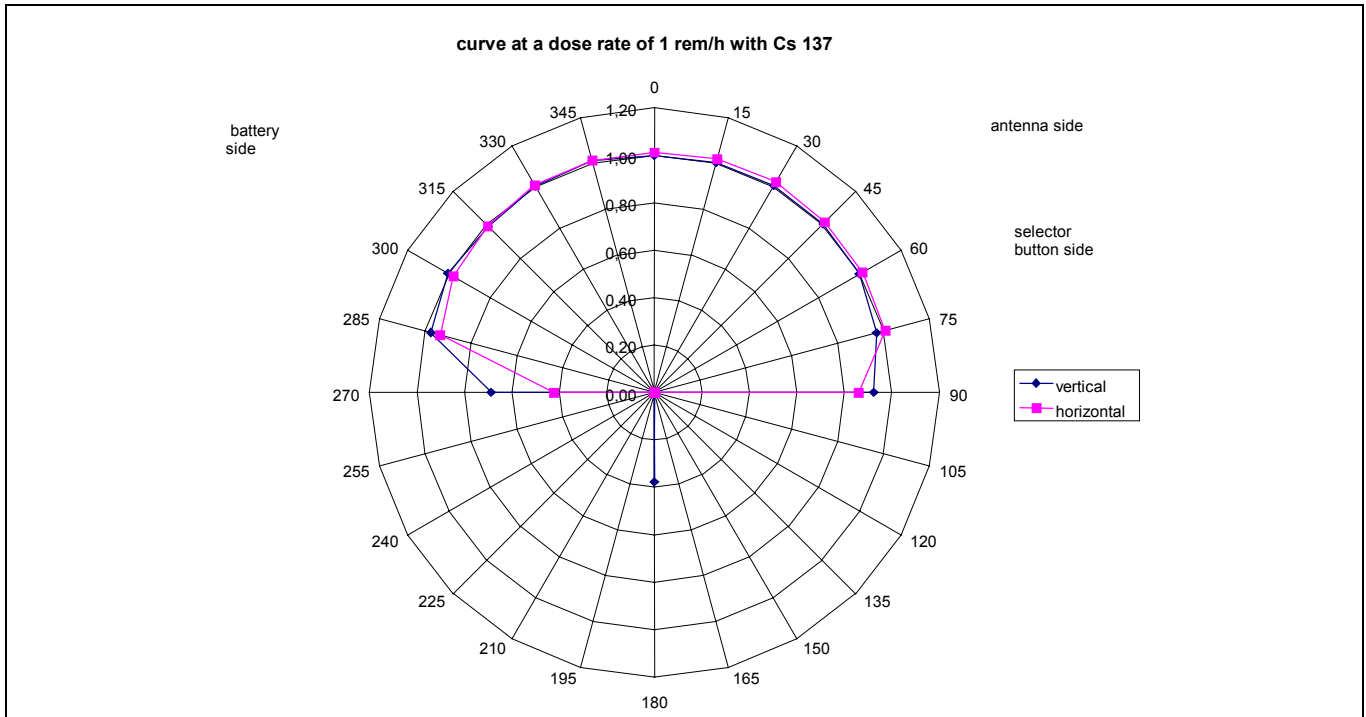

12.1.2. Linearity graph

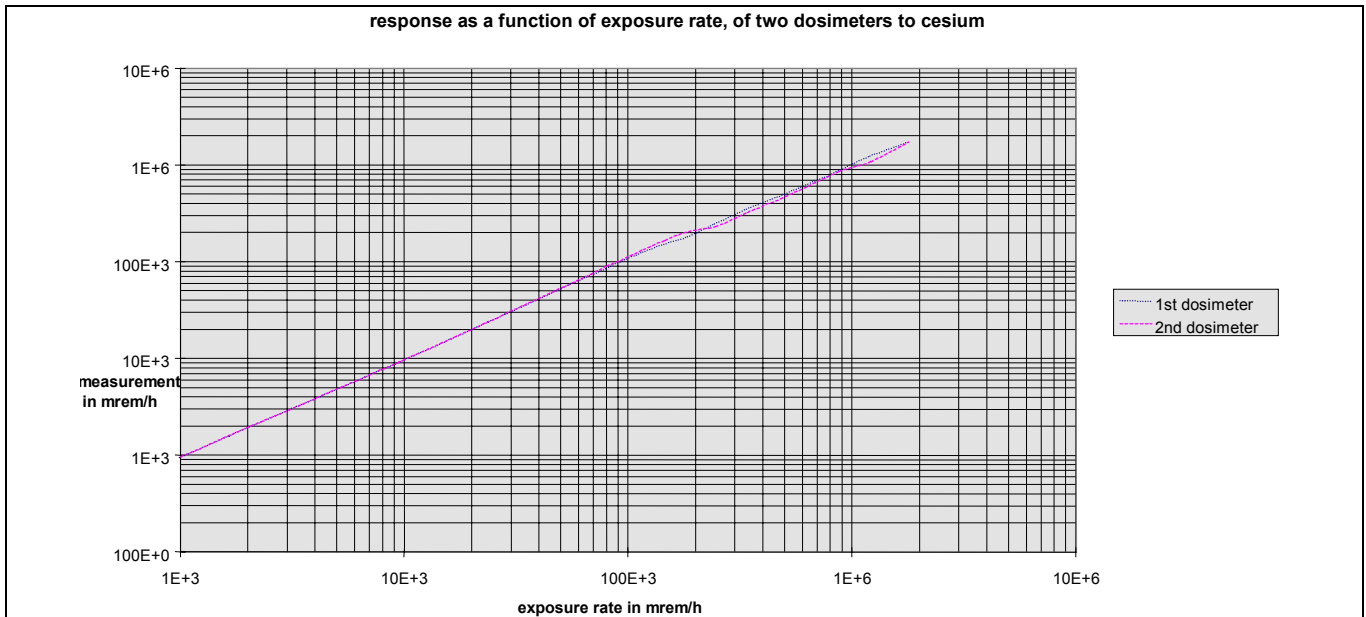

12.2 Functional characteristics

- indicators:
 - LCD display (6 alphanumeric characters + symbols)
 - indicator lights (red light-emitting diode)
 - selector button for acknowledging pre-alarms and viewing the rate
 - buzzer: sound level ≥ 85 dBA at 30 cm (12")

- alarms:
 - precision: the alarm is triggered when the measured value reaches the corresponding alarm threshold value
 - dose alarm: 2 thresholds (alarm and pre-alarm); adjustable over the entire measurement range (only the pre-alarm can be acknowledged)
 - dose rate alarm: 2 thresholds (alarm and pre-alarm); adjustable over the entire measurement range (only the pre-alarm can be acknowledged)
 - acknowledgment is accomplished by pressing and holding the selector button for at least 3 seconds

- checks:
 - periodic detector tests (every 10 min)
 - data integrity test
 - periodic battery tests (every 10 min)
 - battery presence test with audible alarm for 3 min in the event of no battery
 - component test (integrated circuit, E2PROM)

- memory:
 - data storage in E2PROM for more than 10 years
 - historical record of dose increments and events
 - 750 history events at programmable intervals 10 s, 1 min, 10 min, 1h or 24 h (buffer type: First In First Out)

12.3 Electrical characteristics

- power source:
 - battery $\text{LiMnO}_2 / 3\text{V} / \text{CR 2450}$ – (Renata batteries only)
 - lifetime: 1 year of continuous operation (without excessive alarming) under reference conditions (20 ± 5 °C)
 - the dosimeter can be placed in the **storage** mode for 3 years with reduced power consumption

12.4 Mechanical characteristics

- dimensions:
 - Width: 44 mm; 1.76 in.
 - Height: 83 mm; 3.26 in.
 - depth: 9 mm .35 in. (18 mm; .70 in. at the display)
- Weight: approximately 50 g; 1.76 oz.
- drop resistant (up to 25 drops) from a height of 1.5 m (4'9") onto a hard surface

12.5 Environmental characteristics

- operational from - 10 to + 50 °C with a lower than ± 20 % variation in the dose equivalent measurement
- storage temperature - 31°C to + 71°C (without battery)

12.6 Link to LDM 2000 reader

- Pass-by data exchange for activation, deactivation, in-motion data acquisition, reading and writing of parameters
 - normal range of 1.2 m (3'9") for pass-by readings (2.4 m (7'8") if equipped with external antenna)
 - range < 0.5 m for configuration (1'6")

12.7 Storage

In the event the dosimeter will not be used for a prolonged period of time, putting the dosimeter into "storage" reduces its power consumption to a minimum (*dosimeter storage mode*).

In this mode, messages are no longer displayed.

The **LDM 2000** reader is required to put the dosimeter in the storage mode.

13. Replacement parts

The spare parts listed below can be ordered from MGP Instruments.

For special orders or for parts not listed below, contact MGP Instruments' Customer service department.

Name	MGP Instruments' Reference number
battery	D20-2000
battery cover (with seal)	117391
seal separately (for battery cover)	117392
key for changing battery	161 907
clip	114 955

14. Appendix 1:

connector for teledosimetry, alarm transmission or external probe

The DMC 2000S connector allows connection to:

- a teledosimetry transmitter
- an external alarm indicator
- an external probe
- a wired area monitor hub

This appendix describes the various functions of the connector's inputs/outputs.

The functions of the various inputs/outputs of the connector depend on the dosimeter's operating mode. They are described below.

Please contact MGP Instruments for further information.

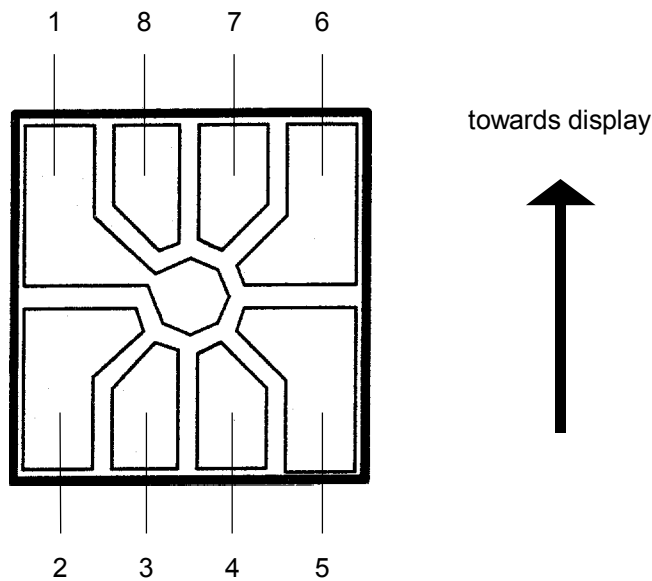

- 1 : ground
- 3, 5 : teledosimetry connection (*WRMPlus*) or area monitor
- 2, 4, 6, 7, 8 : exterior probe or alarm indicator

15. Glossary

IEC : International Electrotechnical Commission (standardization organization)

“**dosimeter storage**” mode: in this mode, the **DMC 2000S** dosimeter is not operational and its power consumption is at a minimum.

“**measurement**” mode: in this mode, the **DMC 2000S** continuously measures the dose and the dose rate, performs periodic checks and activates alarms when applicable. The pass-by data exchange function is active.

“**pause**” mode: in this mode, the **DMC 2000S** performs periodic checks and activates alarms when applicable. The pass-by data exchange function is active.

Pass-by data exchange function: this function allows the **DMC 2000S** dosimeter to communicate with the **LDM 2000** reader without physical contact.

LDM 2000 reader: *pass-by data exchange* reader for **DMC 2000S** dosimeters, which allows them to be configured and used in a centralized dosimetry system.

“**autonomous**” mode: this operating mode allows the **DMC 2000S** to be configured and operated independently, without using any other equipment, such as readers or configuration software.

“**satellite**” mode: this mode is the most typical operating mode of the **DMC 2000S**. It allows a dosimeter to be used in a centralized dosimetry system.